



## Acabado estándar

El clásico acabado en aluminio de los soportes Fiamma



## Acabado negro\*

Acabado negro para que los soportes sean menos visibles en el perfil del vehículo

\* Los soportes disponibles con el acabado negro se indican de la siguiente manera: ●

## KIT AS 110

De serie de 190 a 230 cm

2 soportes de 12 cm  
98655Z007

## KIT AS 120

De serie de 260 a 400 cm

2 soportes de 12 cm  
1 soporte de 8 cm  
98655-391

## KIT AS 400

De serie de 450 a 500 cm

2 soportes de 40 cm  
1 soporte de 12 cm  
98655-390

## KIT AS 400 L

De serie de 550 cm

4 soportes de 40 cm  
98655-393

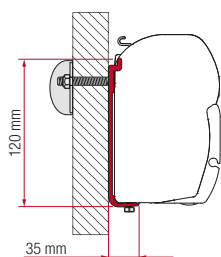

## ADAPTER AS 300

1 soporte de 300 cm  
98655-503

## ADAPTER AS 350

1 soporte de 350 cm  
98655-504

## ADAPTER AS 400

1 soporte de 400 cm  
98655-505

## ADAPTER AS 450

1 soporte de 450 cm  
98655-928

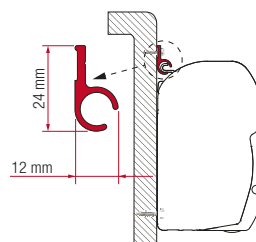

## RAIL

1 Rail de 300 cm  
02361-01A

1 Rail de 400 cm  
02361-01C

## KIT S 120

1 soporte de 12 cm  
98655-392

## KIT S 400

1 soporte de 40 cm  
98655-381

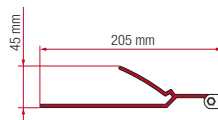

## ADAPTER B

02096-01-

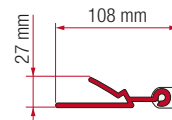

## ADAPTER C

02097-01-

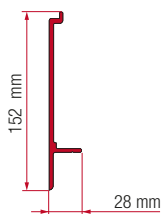

## ADAPTER T

02437-01-

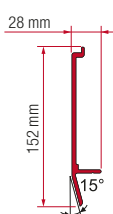

## ADAPTER U

02437A01-

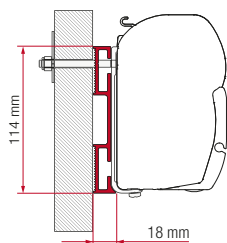
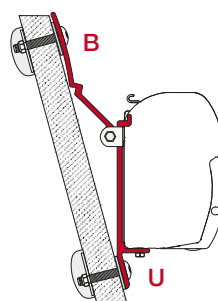
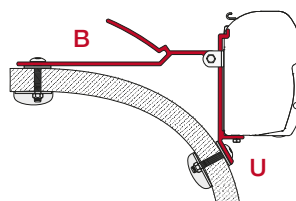
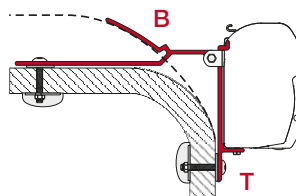

## ADAPTER D

1 soporte de 8 cm  
98655-021

1 soporte de 12 cm  
98655-022

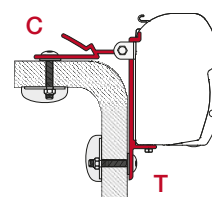
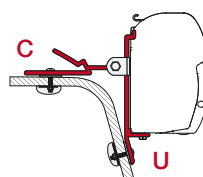

# Soportes F45 / F70

● soportes con acabado negro

\* volante a la derecha

\*\* volante a la izquierda y a la derecha

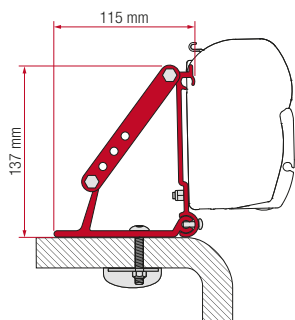

## KIT ROOF ADAPTER

3 soportes de 8 cm  
98655-316

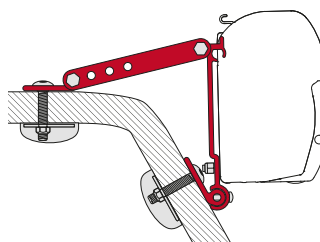

## KIT WALL ADAPTER

3 soportes de 8 cm  
98655-318

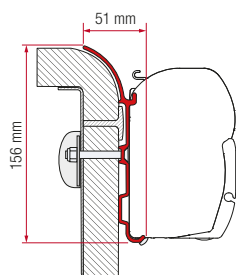

## KIT BÜRSTNER

2 soportes de 12 cm  
1 soporte de 8 cm  
98655-749

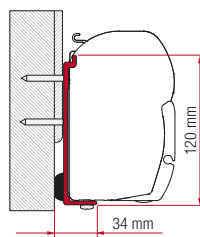

## KIT FLEURETTE

1 soporte de 8 cm  
2 soportes de 12 cm  
98655-082

## ADAPTER BÜRSTNER

1 soporte de 450 cm  
98655-661

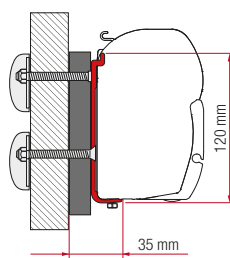

## KIT DETHLEFFS GLOBEBUS

3 soportes de 12 cm  
98655-730

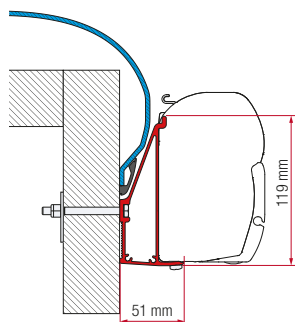

## ADAPTER ARCA

1 soporte de 400 cm  
98655-852

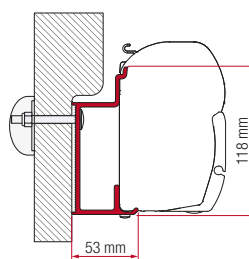

## ADAPTER EURA MOBIL KARMANN

1 soporte de 350 cm  
98655-764

1 soporte de 400 cm  
98655-765

1 soporte de 450 cm  
98655-766

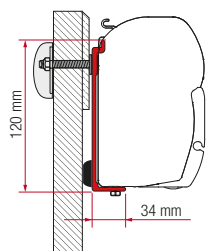

## KIT CHALLENGER CHAUSSON

*Eden Allegro*

2 soportes de 8 cm  
1 soporte de 40 cm  
98655-258

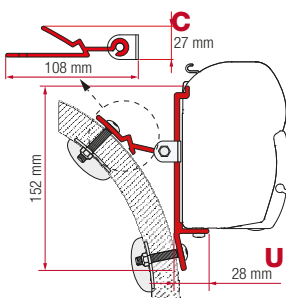

## KIT HYMER S

Pedir:

3 soportes de 8 cm  
02097-01- (1 pc.)

3 soportes de 8 cm  
02437A01- (1 pc.)

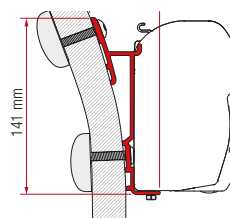

## ADAPTER HYMER S-E KLASSE

*Hymermobile S,  
Klasse 650, 740, 820,  
Esterel desde 2007*

1 soporte de 400 cm  
98655-249

1 soporte de 450 cm  
98655-250

# Soportes F45 / F70

● soportes con acabado negro

\* volante a la derecha

\*\* volante a la izquierda y a la derecha

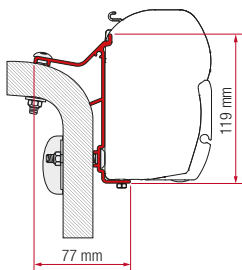

## ADAPTER HYMER VAN/B2

*Hymermobile B, Classic B, Klasse, Starline*

1 soporte de 350 cm  
98655-244

1 soporte de 400 cm  
98655-245

1 soporte de 450 cm  
98655-246

## KIT HYMER VAN/B2

2 soportes de 8 cm  
2 soportes de 35 cm  
98655-243

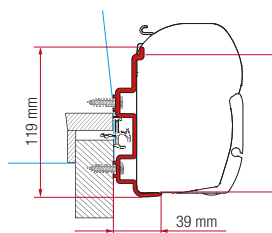

## ADAPTER HYMER EXSIS

*Hasta 2005*

1 soporte de 300 cm  
98655-688

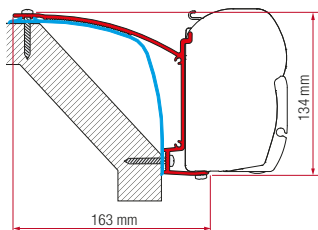

## KIT LAIKA ECOVIP 07

*Para toldos de 4 m*

3 soportes de 15 cm  
98655-467

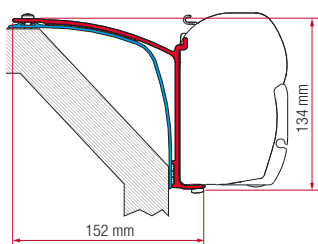

## KIT LAIKA REXOSLINE - ECOVIP 07 - KREOS 09

3 soportes de 15 cm  
98655-418

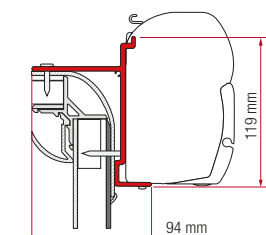

## KIT PILOTE EXPLORATEUR

3 soportes de 15 cm  
98655-729

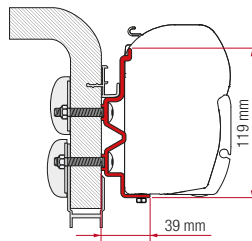

## ADAPTER HYMERCAMP

*Hymercamp Swing, Starline, Hobby Van, Caravan Hobby 09*

1 soporte de 300 cm  
98655-277

1 soporte de 350 cm  
98655-276

1 soporte de 400 cm  
98655-274

1 soporte de 450 cm  
98655-275

1 soporte de 500 cm  
98655-273

## ADAPTER HYMERCAMP

3 soportes de 12 cm  
98655-278

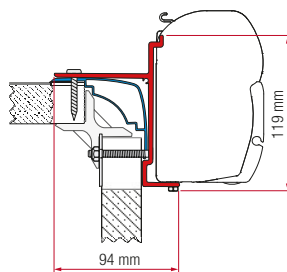

## KIT LAIKA ECOVIP - BÜRSTNER - HOBBY

3 soportes de 15 cm  
1 soporte de 12 cm  
98655-357

## ADAPTER LAIKA ECOVIP

1 soporte de 390 cm  
98655-469

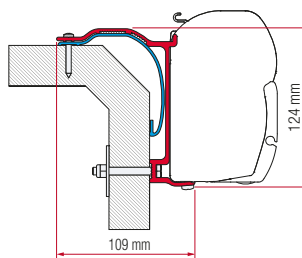

## KIT LAIKA X

3 soportes de 15 cm  
98655-761

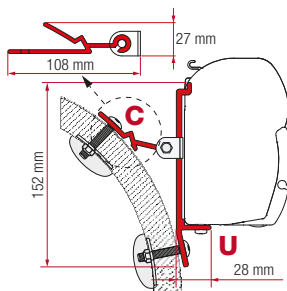

## KIT VOYAGEUR

Pedir:

3 soportes de 8 cm  
02097-01- (1 pz.)

3 soportes de 8 cm  
02437A01- (1 pz.)

# Soportes F45 / F70

● soportes con acabado negro

\* volante a la derecha

\*\* volante a la izquierda y a la derecha

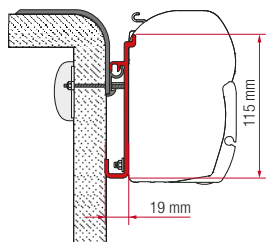

## ADAPTER RAPIDO

Fiat 708F, 710F, 740F,  
Fiat Garage 660, 770F, 772F,  
Mercedes 749M, 779M

1 soporte de 350 cm  
98655-398

1 soporte de 400 cm  
98655-399

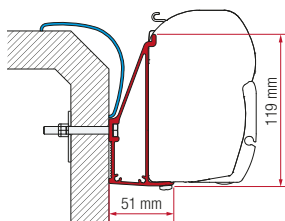

## ADAPTER RAPIDO SERIE 6

1 soporte de 350 cm  
98655-895

1 soporte de 400 cm  
98655-896

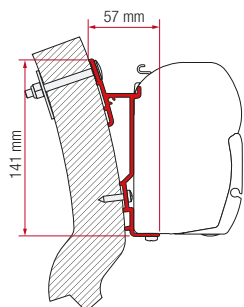

## ADAPTER WINGAMM OASI

Desde 2006

1 soporte de 230 cm  
98655-929

1 soporte de 300 cm  
98655-930

1 soporte de 350 cm  
98655-931

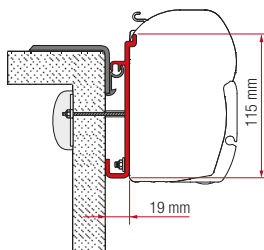

## KIT RAPIDO SERIE 7 - 8

Fiat 860F, Fiat Garage  
860F-870F 890F

2 soportes de 8 cm  
1 soporte de 100 cm  
98655-222

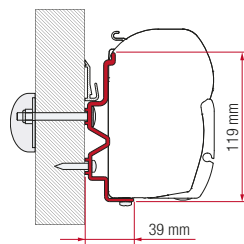

## ADAPTER RAPIDO SERIE 9dF - 9M- 10

Desde 2011

1 soporte de 350 cm  
98655-916

1 soporte de 400 cm  
98655-917

1 soporte de 450 cm  
98655-918

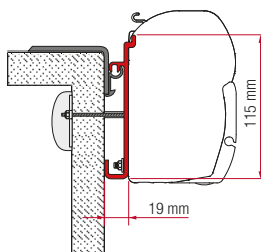

## KIT RAPIDO SERIE 9

2 soportes de 8 cm  
2 soportes de 12 cm  
98655-223

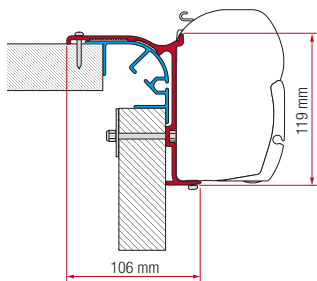

## KIT BAILEY MK 1

Desde 2011 hasta 2013

3 soportes de 15 cm  
98655-879

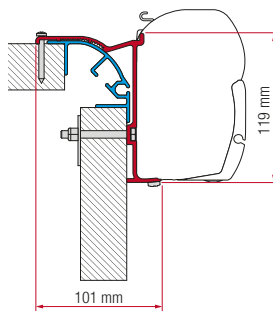

## KIT BAILEY MK 2

Desde 2014

3 soportes de 15 cm  
98655-946

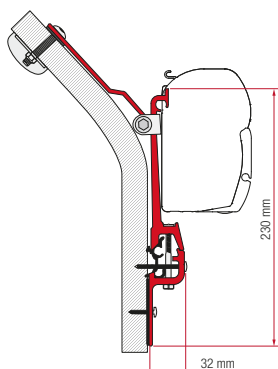

## KIT ERIBA TOURING

Antes 06/2013

3 soportes de 8 cm  
98655-283

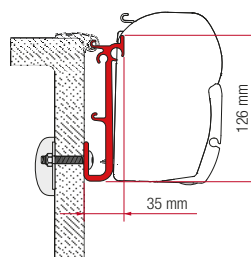

## KIT CARAVAN

3 soportes de 13 cm  
98655-252

# Soportes F45 / F70

● soportes con acabado negro

\* volante a la derecha

\*\* volante a la izquierda y a la derecha

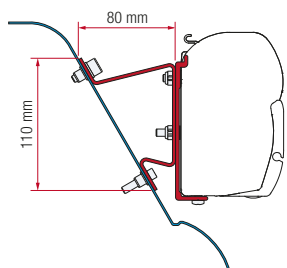

## KIT MERCEDES SPRINTER H3 SPRINTER H3 WESTFALIA VW CRAFTER H3

Desde 2006

3 soportes de 8 cm  
98655-591

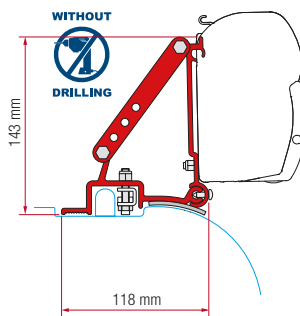

## KIT FIAT DUCATO H2 CITROËN JUMPER H2 PEUGEOT BOXER H2

Desde 2006

2 soportes de 8 cm  
98655-755

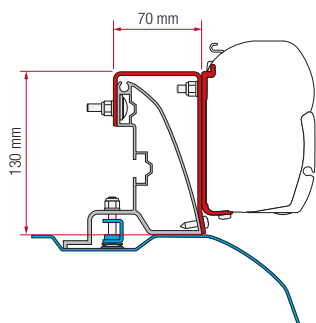

## KIT FIAT DUCATO H2 ROOF RAIL Alu-line Style

Desde 2006

3 soportes de 12 cm  
98655-625

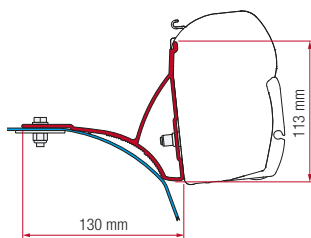

## KIT FIAT DUCATO with ROOF RACK

Desde 2006

3 soportes de 12 cm  
98655-485

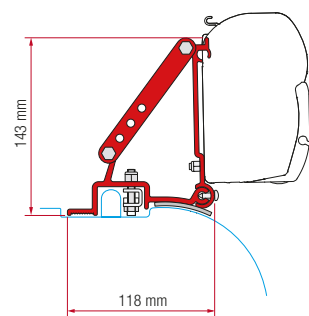

## KIT FIAT DUCATO H2 CITROËN JUMPER H2 PEUGEOT BOXER H2

Desde 1994 hasta 2006

2 soportes de 8 cm  
98655-680

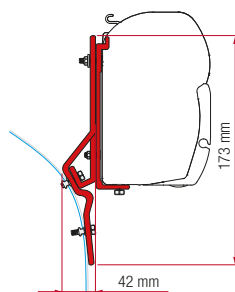

## KIT FIAT DUCATO RENAULT MASTER

Iveco 35C13 City (Fiat New Daily)  
Renault Master desde Marzo 1998  
Para Ducato desde 1984

2 soportes de 14 cm  
98655-286

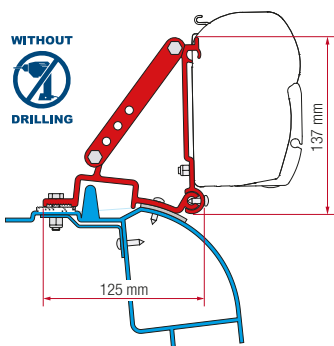

## KIT RENAULT MASTER H2 OPEL MOVANO H2 NISSAN INTERSTAR H2

Desde 1998 hasta 2010

3 soportes de 8 cm  
98655-681

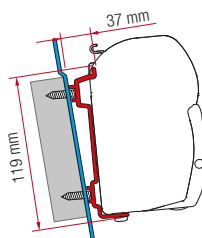

## KIT FORD TRANSIT

H2 hasta 2006  
H3 desde 2015

2 soportes de 40 cm  
98655-741

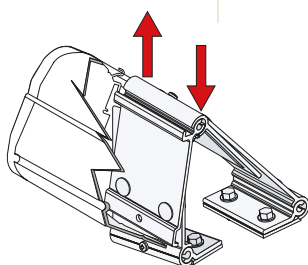
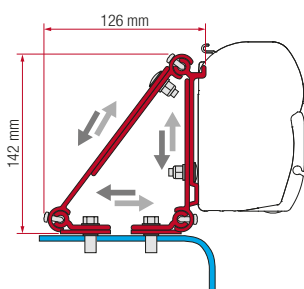

## KIT MULTI

El único soporte modular apto para compensar la curvatura del techo de la furgoneta. Renault Master 98, Fiat Ducato, Citroën Jumper, Peugeot Boxer  
1 soporte de 8 cm  
98655-011

# Soportes F45 / F70

● soportes con acabado negro

\* volante a la derecha

\*\* volante a la izquierda y a la derecha

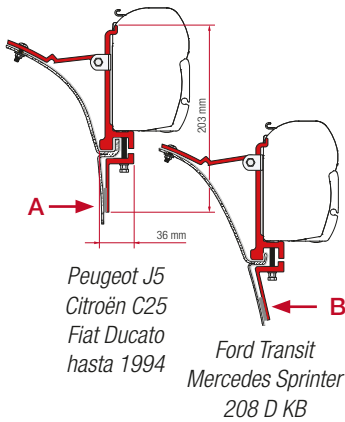

## KIT VAN

Para toldos hasta 3,50m

2 soportes de 8 cm  
98655-017

Soportes A y B suministrados de serie en el kit.

Peugeot J5  
Citroën C25  
Fiat Ducato  
hasta 1994

Ford Transit  
Mercedes Sprinter  
208 D KB

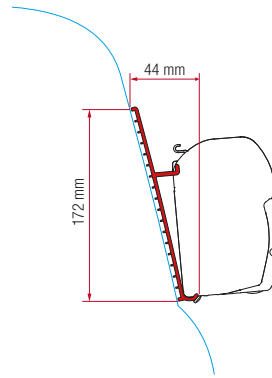

## KIT FIBERGLASS ROOF

2 soportes de 40 cm  
98655-744

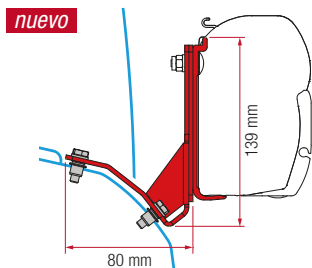

## ● KIT FIAT DUCATO H2 Lift Roof HYMERCAR PÖSSL Lift Roof

3 soportes de 12 cm  
98655Z028

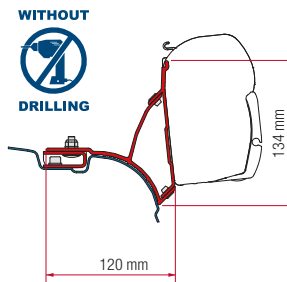

## KIT VW T5/T6 Multivan Transporter

Desde 2003

2 soportes de 21,5 cm  
98655-647

\* 98655-648

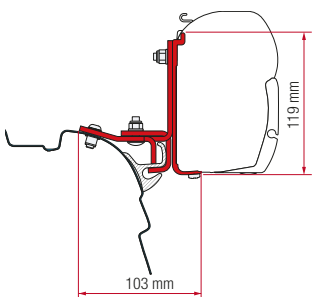

## KIT BRANDRUP VW T5/T6

2 soportes de 12 cm  
98655-627

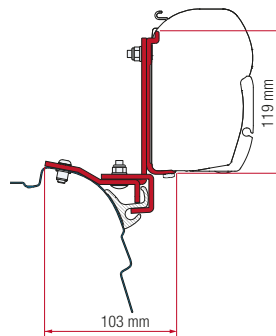

## KIT MULTIRAIL REIMO VW T5/T6

2 soportes de 12 cm  
98655-590

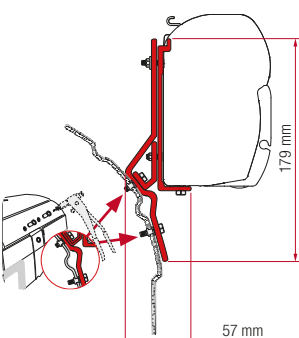

## KIT VW T4 VW T4 Lift Roof

Desde 1991 antes 2003

2 soportes de 14 cm  
98655-292

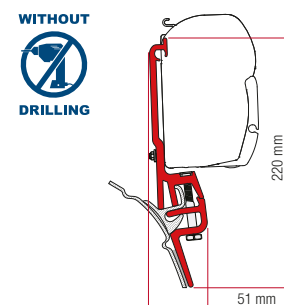

## KIT BRANDRUP VW T4

Reimo Multirail

2 soportes de 8 cm  
98655Z011

# Soportes F45 / F70

● soportes con acabado negro

\* volante a la derecha

\*\* volante a la izquierda y a la derecha

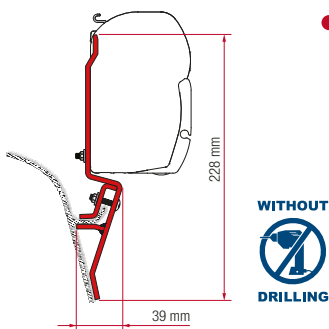

● **KIT VW T3**  
Desde 1980 hasta 1991  
2 soportes de 8 cm  
98655-035

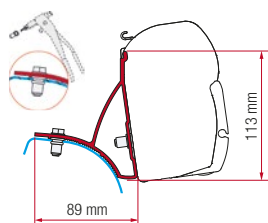

**KIT RENAULT TRAFIC  
OPEL VIVARO  
NISSAN PRIMASTAR**  
Desde 2001 hasta 2015  
2 soportes de 16 cm  
98655-854

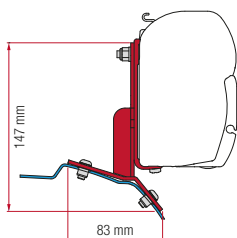

● **KIT FORD CUSTOM**  
*Atención: abrir y cerrar el toldo solo con puertas correderas cerradas. Para uso sólo en combinación con el toldo F45s 2.60m*  
2 soportes de 12 cm  
\*\* 98655Z025

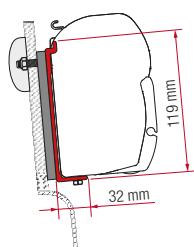

**KIT HIGH ROOF  
ADAPTER WESTFALIA**  
2 soportes de 12 cm  
98655-317

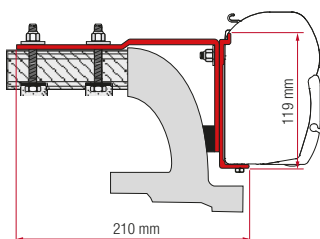

**KIT MERCEDES VITO**  
Hasta 2004  
2 soportes de 14 cm  
98655-284

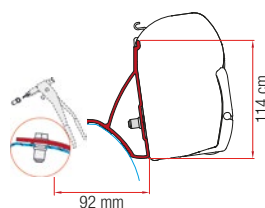

**KIT RENAULT TRAFIC  
OPEL VIVARO  
NISSAN NV300  
FIAT TALENTO**  
Desde 2015  
2 soportes de 16 cm  
98655Z021

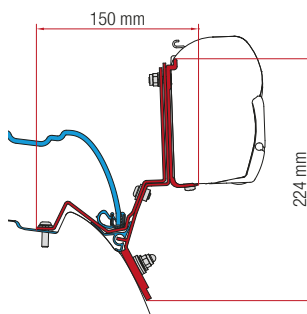

**KIT V CLASS MARCO POLO**  
Desde 2014  
*No apto para Marco Polo con techo eléctrico*

1 soporte de 12 cm  
1 soporte de 13 cm  
98655Z022

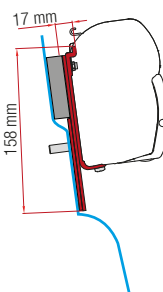

**KIT FORD  
CUSTOM NUGGET**  
2 soportes de 12 cm  
98655Z023

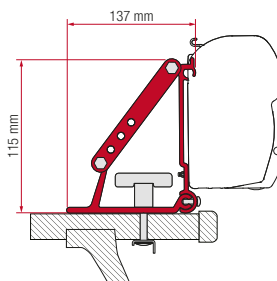

**KIT AUTO**  
2 soportes de 8 cm  
98655-310

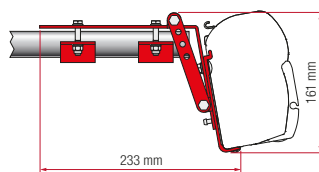

**KIT ROOF RAIL**  
*Anchura max Rail 5,5cm  
Min. 2 Kits para instalar un toldo*  
1 soporte de 12 cm  
98655-770